



EXPANSIÓN EN EL STR

Resolución CREG 024 de 2013

Barranquilla, septiembre de 2013

 **PROSPERIDAD
PARA TODOS**



Temario

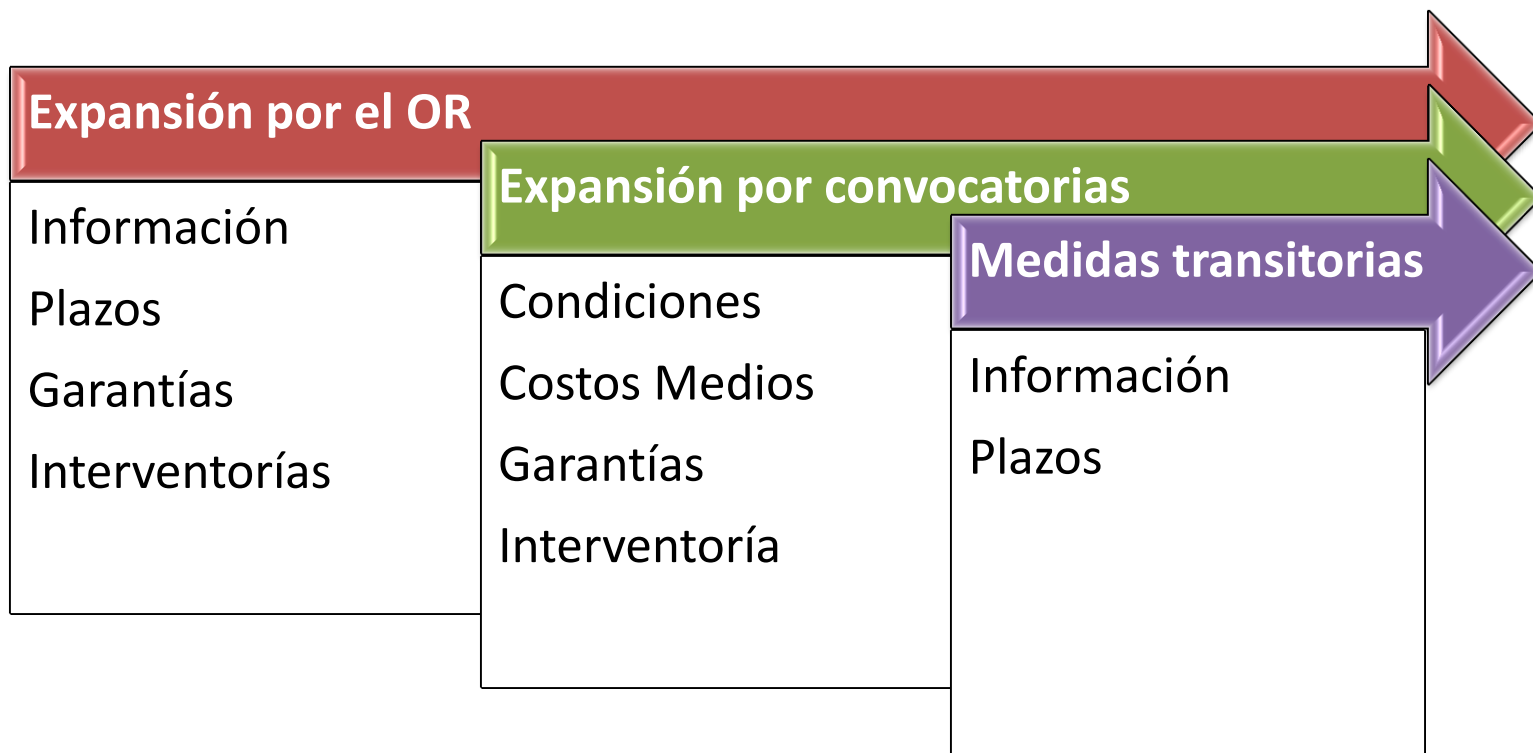

Expansión por parte del OR

Horizontes Planeación

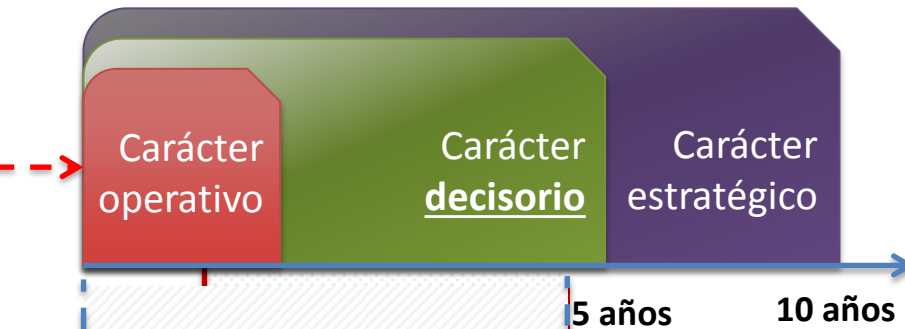

Plazo: 15- jun c/año

Cada proyecto del sistema del OR:

- Planeamiento Estándar
- Planeamiento Detallado

- estudios
- FPO
- Justificad

48 meses

36 meses

Plazo: + 4 meses
publicación PE

- manifestación del OR
- cronograma
- Interventor
- garantía



Lista de proyectos STR

OR

Otros OR

Señales

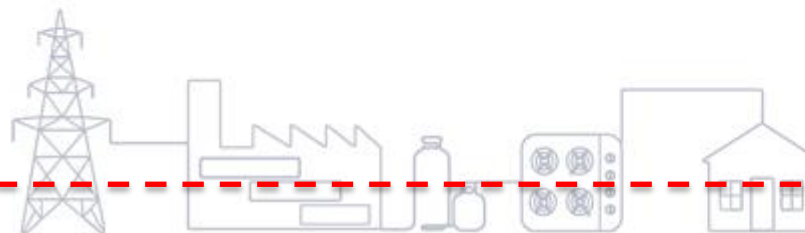

PROSPERIDAD
PARA TODOS



Expansión por el OR: INTERVENTORÍA

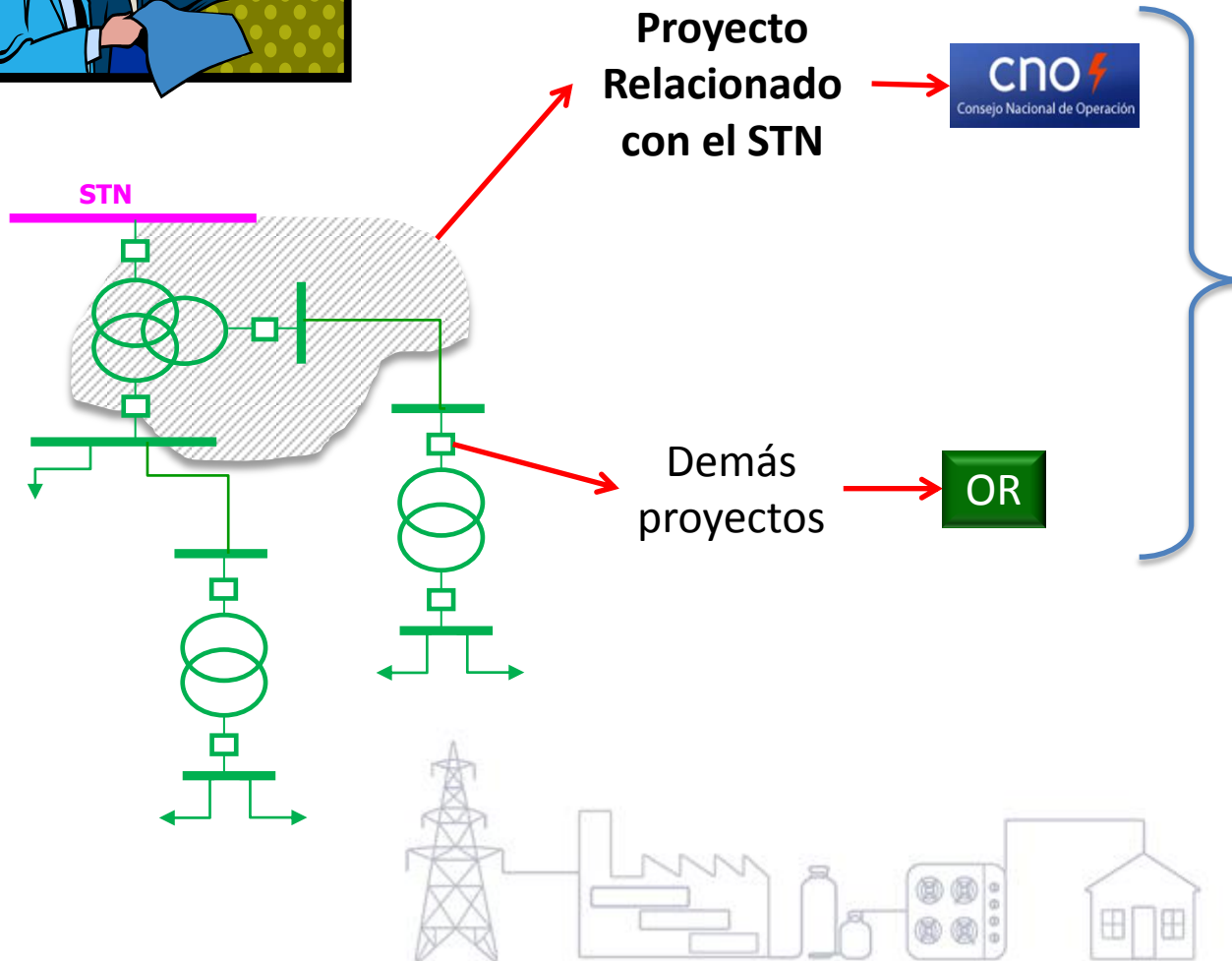

- ✓ Información avance
- ✓ Estimación FPO real
- ✓ Verificación UC
- ✓ Incumplimiento grave e insalvable



Expansión por el OR: GARANTÍA

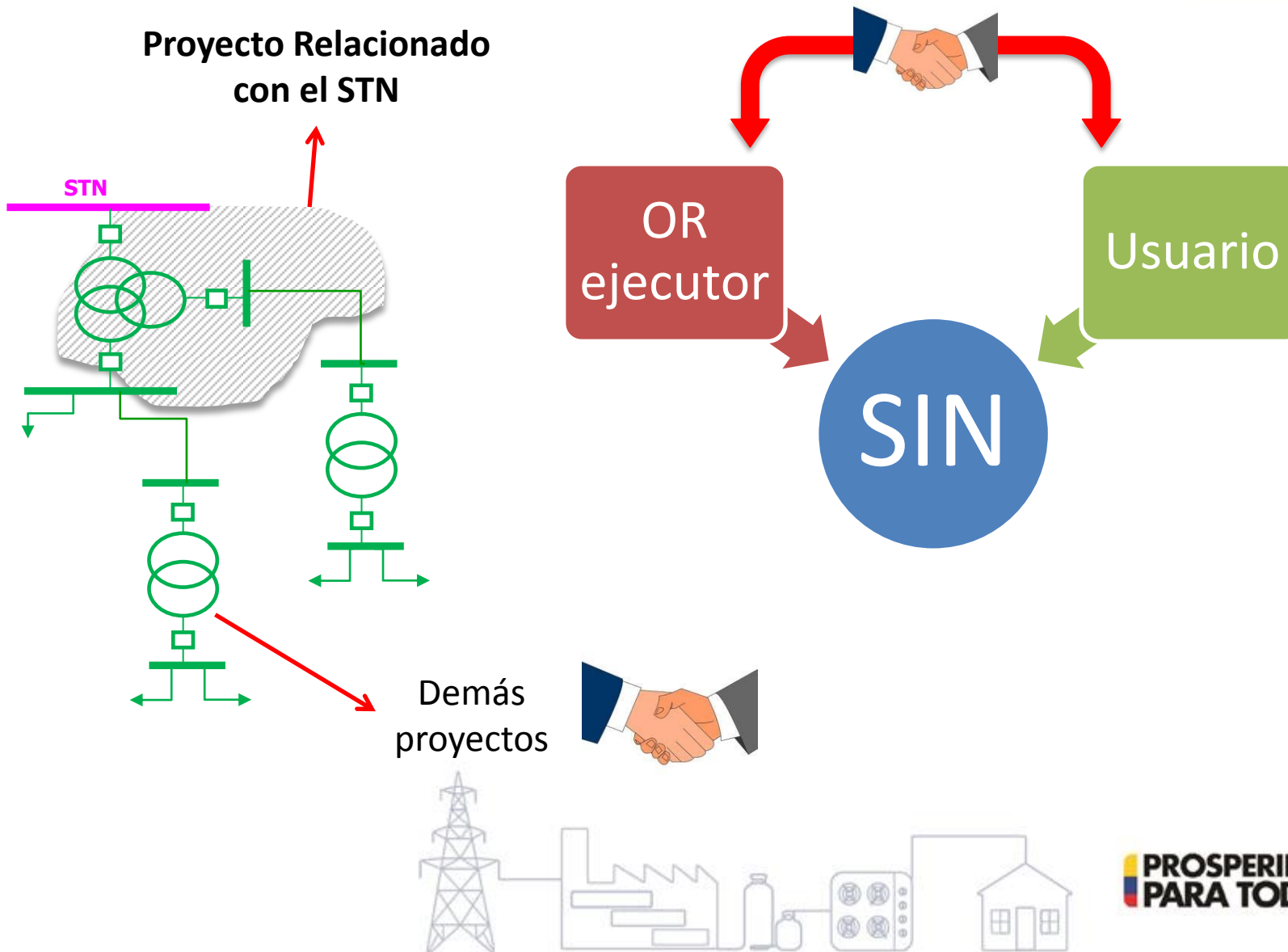

Expansión por parte del OR

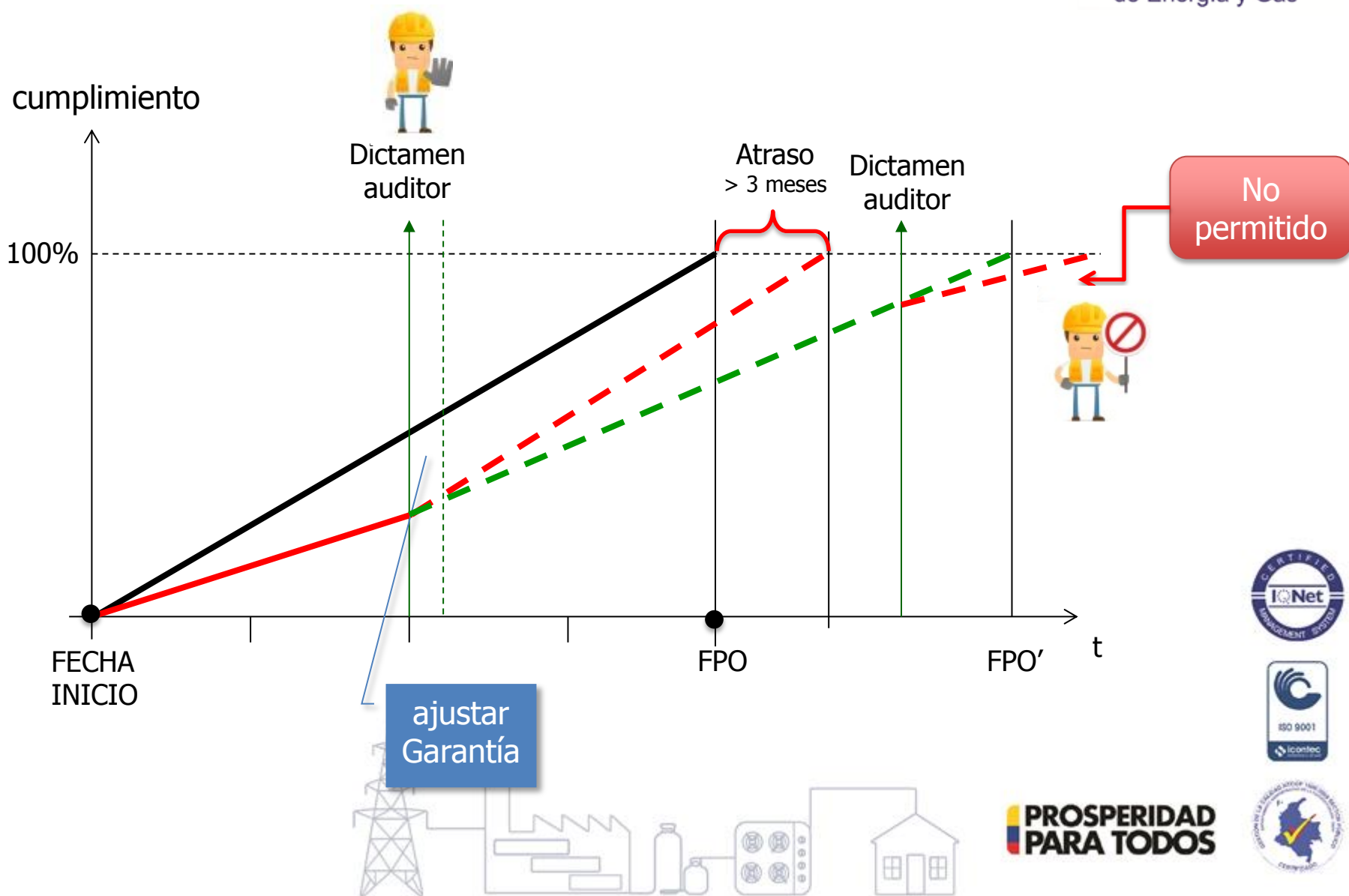

Expansión por convocatorias

Participan: **Otros OR y TR**
Tope ofertas: **valor UC**

Participan: **OR y TR**
Sin valor tope, **min. 2 ofertas**

No se realiza
expansión por
OR

Costo mayor a
CM

Proceso de Selección

Garantías

Resolución
CREG 097 de
2008

Selección:
**Oferta con menor
VP**

Interventoría
Lista: **CNO**
Selección: **UPME**



**PROSPERIDAD
PARA TODOS**



Expansión por convocatorias

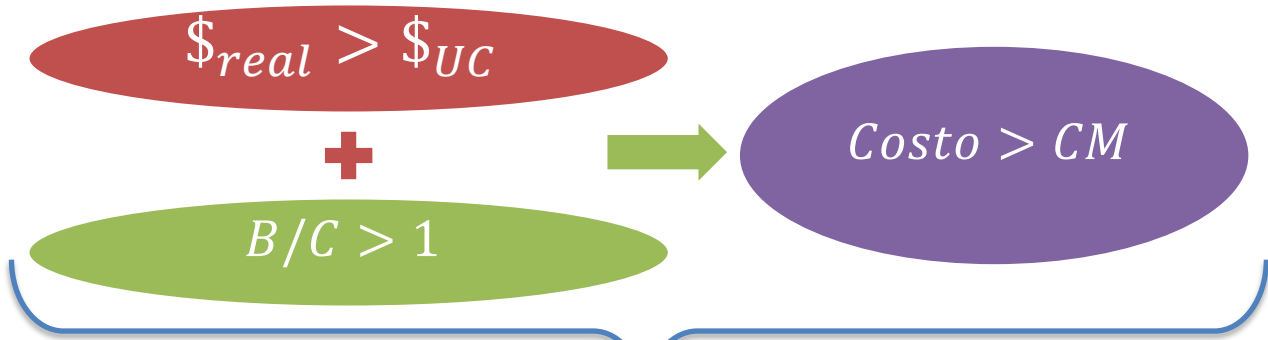

$$\text{Costo Medio} = CD_4 = \frac{\text{Ingresos OR}}{\text{Demanda}}$$

No requiere
revisión



Medidas transitorias

Proyectos FPO 36 meses siguientes:

- Manifestación interés
- Cronograma
- Interventor
- Garantía

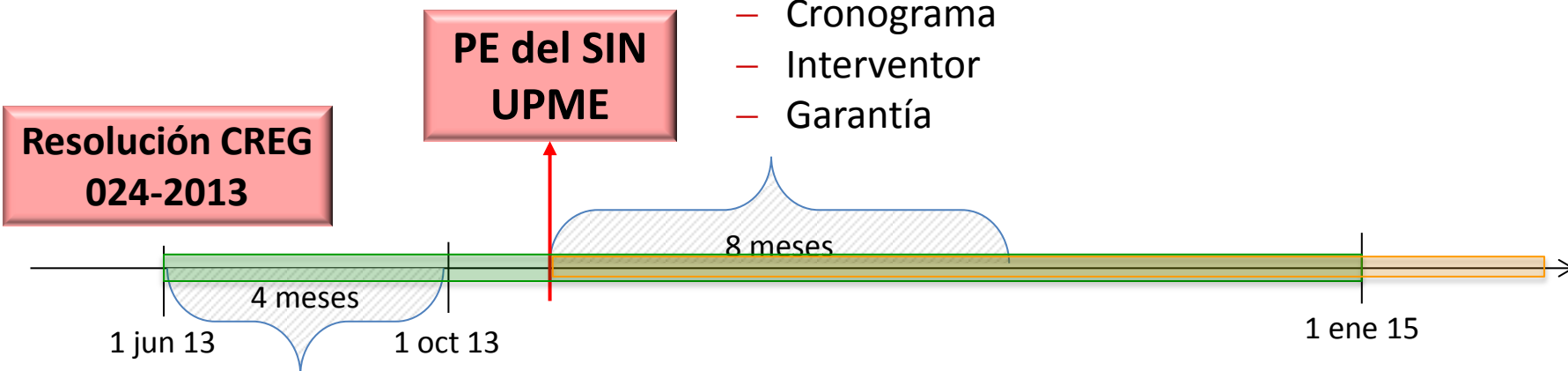

PE del OR

Proyectos con concepto UPME:

- Manifestación interés
- Cronograma
- Interventor
- Garantía

Proyectos requeridos antes de 1-ene-2015





Comisión de Regulación de Energía y Gas – CREG
Calle 116 No. 7-15 Piso 9
PBX: 6032020 FAX: 6032100
Email: creg@creg.gov.co
Página Web: www.creg.gov.co
Bogotá D.C.

 **PROSPERIDAD
PARA TODOS**

